



Manao ⁴

Nastro ⁴⁴

Metropolii ⁶⁴

Panneli ⁸⁴



Madera TV 210 Stand, Deep Ocean finish

Manao Collection

Fondu × Studio LATO × Ewelina Madalińska × Weronika Wojnarowicz



Gabbia Console 177, Vulcanic finish / Nastro Console, Pure Black finish



Sorella Sideboard in solid oak veneer with powder-coated steel legs for durability and style. Versatile centerpiece for any contemporary or classic interior.

Manao Collection
embodies furniture that
is minimalist in form
yet bold in expression.
It represents the perfect
balance of refined
elegance and simplicity.

The Manao Collection showcases simple forms that don't have to scream to stand out. Clean lines, precise craftsmanship and balanced proportions allow these designs to harmonize effortlessly within your interior.

Crafted from premium materials, the collection features timeless shapes and colors, ensuring longevity and relevance in any setting. The Manao furniture is designed with precision, prioritizing both form and function. This collection embraces the golden rule of geometry: curves, minimalist compositions and contemporary elegance combined with traditional sophistication.

Manao offers something for everyone, but it's especially designed for those who appreciate exquisite design. It's streamlined form and attention to detail guarantee seamless integration into both modern and classic interiors.

Key Pieces in the collection:

- Madera TV Stand (140, 190, 210)
- Sorella Sideboard
- Gabbia Console (177, 131)
- Yen Night Stand
- Veroni Coffee Table
- Portafortuna Console



Madera TV Stand Collection available in three versatile sizes - 140 cm, 190cm, 210cm - it adapts seamlessly to various interior layouts while making a sophisticated statement. Color palette: choose from a curated selection of finishes, including: DEEPOCEAN, PETRA, WALNUT OAK-each designed to harmonize with modern and classic decor



Madera TV Stand, Natural oak finish. Slatted wood detailing and curved edges ensure a perfect balance of form and function

TV STAND

Madera 140





Madera TV stand 140, Petra finish



Madera TV Stand 190, Vulcanic finish/ the Yen Night Stand, Vulcanic finish / The Raggi Prime Wall Panels, Natural Oak finish

Madera 140

FINISHES

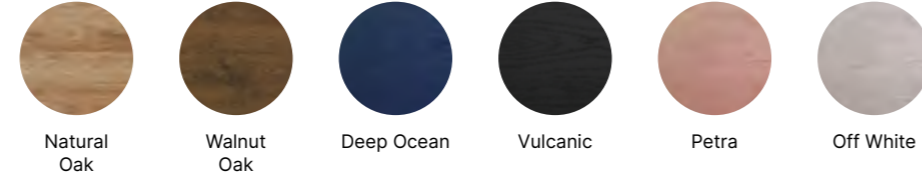

Natural Oak Walnut Oak Deep Ocean Vulcanic Petra Off White

KEY FEATURES

Dimensions:

height: 65cm (body height 40 cm+legs 15 cm)
width: 140 cm
depth: 40 cm

Materials:

Crafted from lacquered oak veneer and steel legs with a powder-coated matte finish. The quartz stone top - 3mm (could be an option) which adds an extra layer of luxury and durability.

Production

Proudly designed and produced in Poland, combining traditional craftsmanship with innovative techniques.

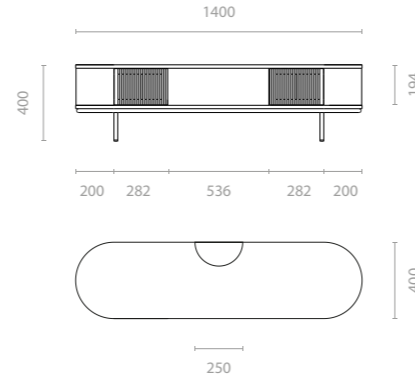

DESIGNERS

Fondu x Eliza Czumaj & Magdalena Szemborska Lubik - LATO Studio



Madera 140 Tv Stand - Walnut oak finish



Madera TV Stand 190, Deep Ocean finish

TV STAND

Madera 190





Madera TV Stand 190, Off White finish

Madera 190

FINISHES

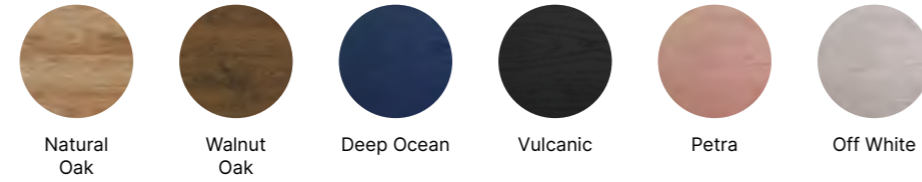

KEY FEATURES

Dimensions :

height: 45 cm (body height: 30 cm + legs 15 cm)
width: 190 cm
depth: 40 cm

Materials:

Body: Lacquered oak veneer
Slats: solid oak wood for an elegant, tactile finish
Legs/Frame: powder-coated steel in a matte black finish
Top: 3mm quartz stone for added durability and luxury

MADE IN POLAND: this piece reflects meticulous attention to detail and superior craftsmanship since 2019. The Madera 190 TV Stand redefines functional elegance, offering a redefines statement for modern living.

DESIGNERS

Fondu × Eliza Czumaj & Magdalena Szemborska Łubik – LATO Studio

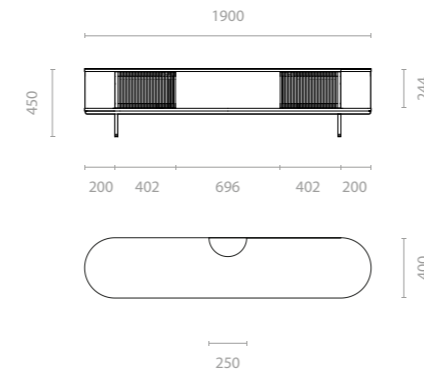

Raggi Wall Prime Panels Natural Oak finish / Madera TV Stand 190, Vulcanic finish



Madera TV 210 Stand TV, Natural Oak finish

TV STAND

Madera 210





Madera TV Stand 210, Natural oak finish / Primavera Planter 45, color Off White



Madera TV Stand 210, Walnut oak finish / Gabbia Console 177, Walnut Oak finish / Mood66 Coffee Table, Burgundy finish / Mood 46 Coffee Table Pure Black finish

Madera 210

FINISHES

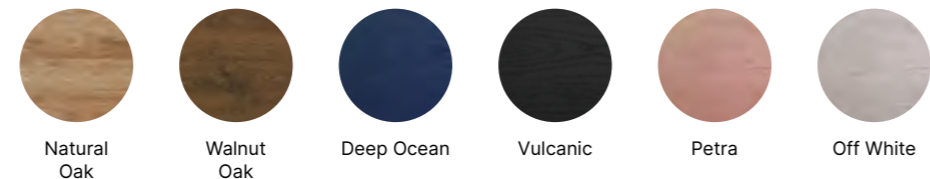

Natural Oak

Walnut Oak

Deep Ocean

Vulcanic

Petra

Off White

KEY FEATURES

Dimensions :

height total: 65 cm (body: 50 cm + legs 15 cm)
width: 210 cm
depth: 45 cm

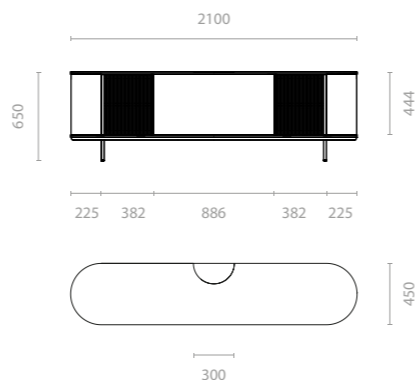

Materials:

Body: lacquered oak veneer
Lamellas: Solid oak wood
Frame/Legs: Powder-coated steel - matte black
Accessories: 3mm quartz sinter

Production

2019, made in Poland

DESIGNERS

Fondu × Eliza Czumaj & Magdalena Szemborska Łubik – LATO Studio



Madera 210 Tv Stand , Walnut Oak finish



Sorella, Sideboard, Natural oak finish

SIDEBOARD

Sorella





Sorella

FINISHES



FRAME variants

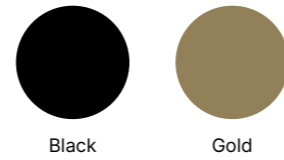

KEY FEATURES

Dimensions :
 height: 85 cm (body: 55 cm + legs: 30 cm)
 wight: 120 cm
 depth: 50 cm

Materials:
 Tops: veneered board with visible wood texture
 Shelves: veneered board with visible wood texture
 Legs: steel

Production
 2021, made in Poland

DESIGNERS

Fondu x Ewelina Madalińska
 Interior Designer Industrial Design, graduate of the Academy of Fine Arts in Łódź and Product Design at German university at Hochschule Niederrhein. She runs design studio "Wyborne".

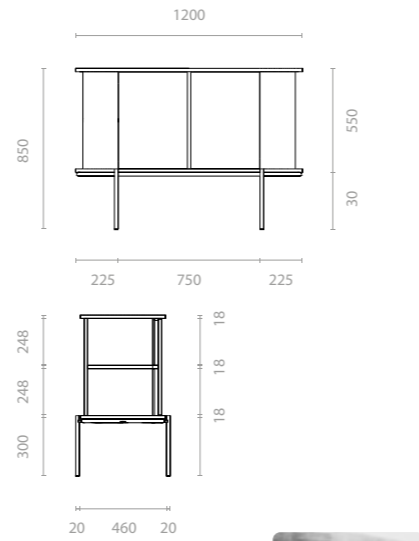

Sorella sideboard, Vulcanic finish / Primavera Planter 45 in Coffee tone Color. This combination creates a perfect harmony of modern elegance and timeless sophistication, blending earthy tones with sleek, minimalist design. The Sorella sideboard, with its refined slatted detailing, beautifully complements the Primavera planter, making it an ideal choice for curated interior spaces.



Gabbia Cabinet 177, Volcanic finish

ECLAT CABINET

Gabbia 177





Gabbia 177 Cabinet, Vulcanic finish

Gabbia 177

FINISHES

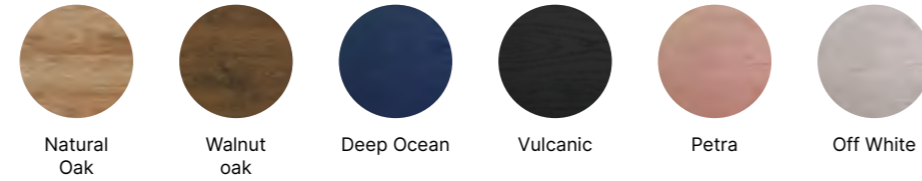

KEY FEATURES

Dimensions:

height: 177 cm
width: 100 cm
depth: 50 cm

Materials:

Body Slats: solid oak with a visible wood texture
Shelves: Veneered board with a natural wood grain finish
Frame: powder-coated steel in matte black

Production

Made in Poland
Handcrafted in Poland from premium-grade

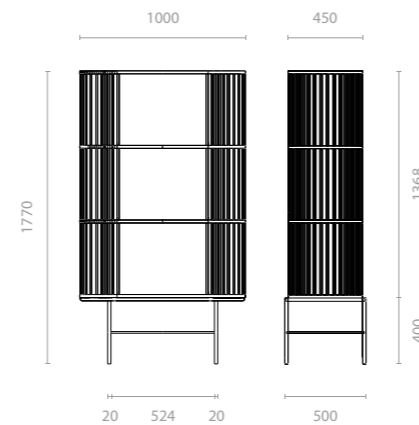

DESIGNERS

Fondu × Ewelina Madalińska

Interior Designer Industrial Design, graduate of the Academy of Fine Arts in Łódź and Product Design at the German university Hochschule Niederrhein. She runs design studio "Wyborne"



Gabbia 131 Cabinet, Vulcanic finish / Gabbia 177 Cabinet, Natural Oak finish



Gabbia 131 Cabinet, Walnut Oak finish/ Primavera 45 Planter Deep Ocean finish



Gabbia 131 Cabinet, Natural Oak finish / Mood 66 Coffee Table in Coffee Tone / reflected: Raggi Panels Oak finish

CABINET

Gabbia 131





Gabbia 131 Cabinet Walnut finish / Primavera 45 Planter in Burgundy colour / Mood 66 Coffee Table coffee-tone finish / fragment of Madera 140 Petra finish

Gabbia 131

FINISHES

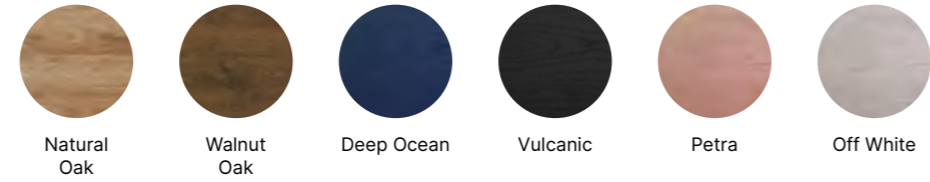

Natural Oak Walnut Oak Deep Ocean Vulcanic Petra Off White

KEY FEATURES

Dimensions:

height: 131 cm
width: 100 cm
depth: 50 cm

Materials:

Slats in the body: solid oak wood with a visible wood grain texture
Tops: veneered board with a natural wood grain texture
Frame: Powder-coated steel in a matte black finish

Production

Proudly made in Poland

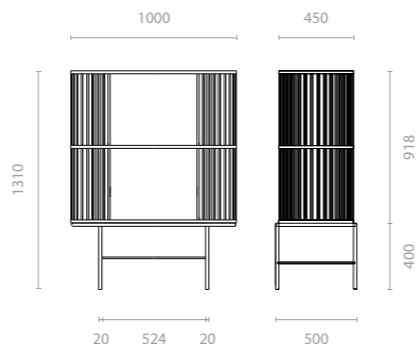

DESIGNERS

Fondu x Ewelina Madalińska

Interior Designer Industrial Design, graduate of the Academy of Fine Arts in Łódź and Product Design at the German university Hochschule Niederrhein. She runs design studio "Wyborne"



30Gabbia Cabinet 131, Walnut oak finish

Gabbia Cabinet 131, Walnut oak finish



Console table BENVENUTI 7,7

FINISHES



Natural
Oak



Walnut
Oak



Deep Ocean



Vulcanic

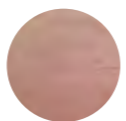

Petra



Off White

KEY FEATURES

Dimensions

height: 100 cm
width: 140 cm
depth: 30 cm

Materials

Drawer Finish: Black matte, off-white, or gold veneer.
Solid Oak Wood Veneer: Flader type grain.
Frame: Powder-coated steel.

Features

Two drawers with soft-close mechanisms.
Customizable color configurations available through the online store configurator.
All finishes feature visible wood grain

Production

2024, made in Poland

PROJECT

Fondu X Ola Ziareq

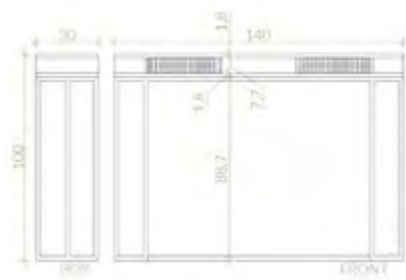



Console table BENVENUTI 17,7

FINISHES



Natural
Oak



Walnut
Oak



Deep Ocean



Vulcanic

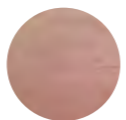

Petra



Off White

KEY FEATURES

Dimensions

height: 100 cm
width: 140 cm
depth: 30 cm

Materials

Drawer Finish: Black matte, off-white, or gold veneer.
Solid Oak Wood Veneer: Flader type grain.
Frame: Powder-coated steel.

Features

Two drawers with soft-close mechanisms.
Customizable color configurations available through the online store configurator.
All finishes feature visible wood grain

Production

2024, made in Poland

PROJECT

Fondu X Ola Ziareq





APPUNTI Desk

FINISHES



Natural
Oak



Walnut
Oak



Deep Ocean



Vulcanic



Petra



Off White

KEY FEATURES

Dimensions

height: 74,5 cm
width: 140 cm
depth: 60 cm

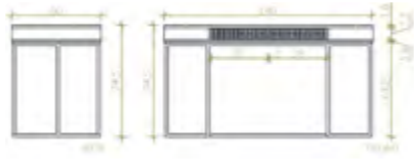

Materials

Drawer Finish: Black matte, off-white, or gold veneer.
Solid Oak Wood Veneer: Flader type grain.
Frame: Powder-coated steel.

Features

Two drawers with soft-close mechanisms.
Customizable color configurations available through the online store configurator.
All finishes feature visible wood grain.

Production

2024, made in Poland

PROJECT

Fondu X Ola Ziareq





Yen Night Stand, Natural Oak finish



Yen Night Stand, Volcanic finish / Raggi Prime Wall Panels, Natural Oak finish

NIGHT STAND

Yen





Madera TV Stand 140 Off White finish / Yen Night Stand, Burgundy finish

Yen

PALETTE OF FINISHES

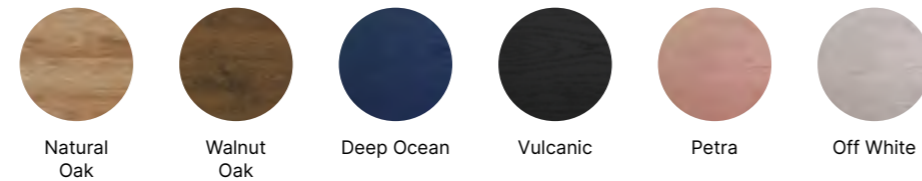

Natural Oak Walnut Oak Deep Ocean Vulcanic Petra Off White

KEY FEATURES

Dimensions :

height: 50 cm (body: 12cm, legs: 38 cm)
width: 40 cm
depth: 40 cm

Materials:

Body: oak veneer, lacquered finish
Legs: powder-coated steel in matte black
Additional features: 3mm quartz composite

Production

2019, Handcrafted in Poland

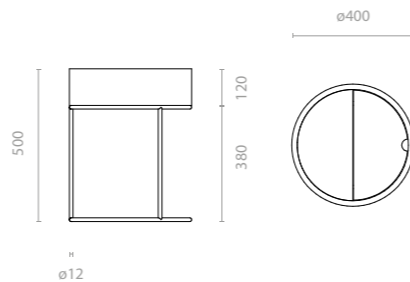

DESIGNERS

Fondu × Eliza Czumaj & Magdalena Szemborska Łubik – LATO Studio



Yen Night Stand, Deep Ocean finish



Veroni Side Table, Petra finish / Madera 140 TV Stand Petra finish / Primavera 45 Planter Off White finish / Arco Prime Wall Panels Walnut oak finish

SIDE TABLE

Veroni





Veroni Side Table, Veri Peri finish

Veroni

PALETTE OF FINISHES



KEY FEATURES

Dimensions:

height: 46,8 cm
width: 40 cm
depth: 40 cm

Materials

Base: furniture board veneered with oak flader veneer finish
Finish Options: available in Natural Oak and Walnut Oak finishes
Includes a distinctive black stripe on the arc of the top surface

Production

2022, Crafted in Poland

DESIGNERS

Fondu × Ewelina Madalińska & Weronika Wojnarowicz

Product, innovation and service designer
Graduate of the Academy of Fine Arts in Łódź, Faculty of Design Arts.

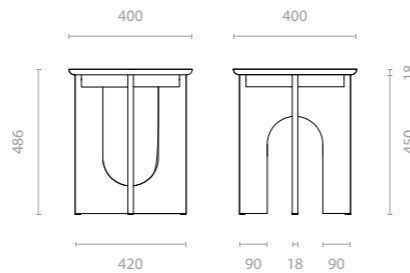
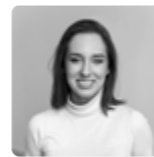

Veroni Side Table-Off Blue finish / Gabbia 177 Cabinet, Walnut Oak finish / Raggi Prime Wall Panels, Walnut oak finish / Dinamica Coffee Table, Vulcanic finish / Veroni side table Deep Ocean finish



Portafortuna Mirror Console, shelf Walnut Oak finish



Portafortuna Mirror Console, shelf Walnut Oak finish

MIRROR CONSOLE

Portafortuna





Portafortuna Console - shelf walnut oak finish / Arco prime panels, walnut oak finish

Portafortuna

PALETTE OF FINISHES

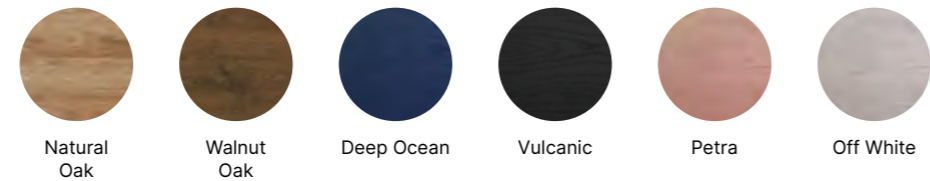

Natural Oak

Walnut Oak

Deep Ocean

Vulcanic

Petra

Off White

KEY FEATURES

Dimensions:

height: 206 cm
width: 80 cm (mirror: 78 cm)
depth: 20 cm

Materials:

Frame: powder-coated steel in matte black
Top: lacquered oak veneer
Additional Features : mirror

Production

2019, Crafted in Poland

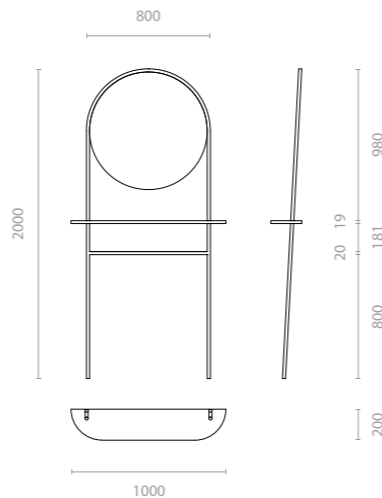

DESIGNERS

Fondu × Eliza Czumaj & Magdalena Szemborska Łubik – LATO Studio



Portafortuna Mirror Console, shelf Natural oakfinish



Primavera 45 Planter, Pure Black finish

Nastro Collection

Fondu × Ewelina Madalińska



Nastro Console, Pure Black finish



Gabbia 131 Cabinet, natural oak finish / Mood 66 coffee table, coffee tone finish

The furniture from the Nastro collection serves as a versatile piece, doubling as an exceptional decorative element, much like ribbons on a meticulously wrapped gift. The Nastro collection embodies the essence of Fondu's style, blending simplicity with originality.

The Nastro collection embodies the essence of Fondu's style, blending simplicity with originality. The name of the collection (derived from the Italian word for "ribbon") perfectly reflects its minimalist yet decorative character. Straight lines elegantly transition into asymmetrical, rounded shapes, offering an intriguing alternative to heavy, traditional forms. Each piece of furniture is crafted using premium materials and high-quality steel components. The combination of innovative forms, minimal raw material usage, and an inspiring color palette ensures that these designs effortlessly enhance any interior.

The collection's palette allows for playful exploration of warm, cool, and neutral tones, all of which can be freely combined to create unique compositions that perfectly reflect your personality.

The collection includes:

- Mood coffee table (46, 66)
- Primavera planters
- Nastro Console



Nastro Console, Off white finish



Mood Coffee table 66, Coffee tone finish

COFFEE TABLE

Mood 46





Mood Coffee table 66, Olive Green finish / Mood Coffee table 46, Pure Black finish

Mood 46

PALETTE OF FINISHES

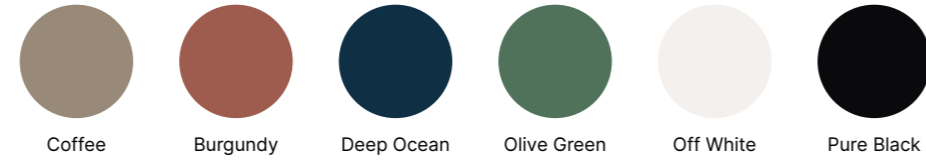

KEY FEATURES

Dimensions:
height: 46 cm
top size: 70 cm

Materials:

Top: Steel
Legs: Steel

Production
2021, Created in Poland

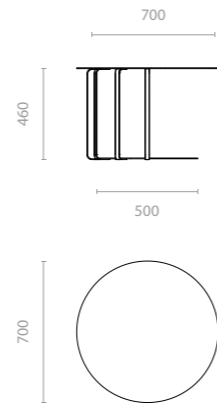

DESIGNERS

Fondu × Ewelina Madalińska

Industrial Design, graduate of the Academy of Fine Arts in Łódź and Product Design at German university at Hochschule Niederrhein. She runs design studio "Wyborne"





Mood Coffee table 66, Olive Green finish

COFFEE TABLE

Mood 66

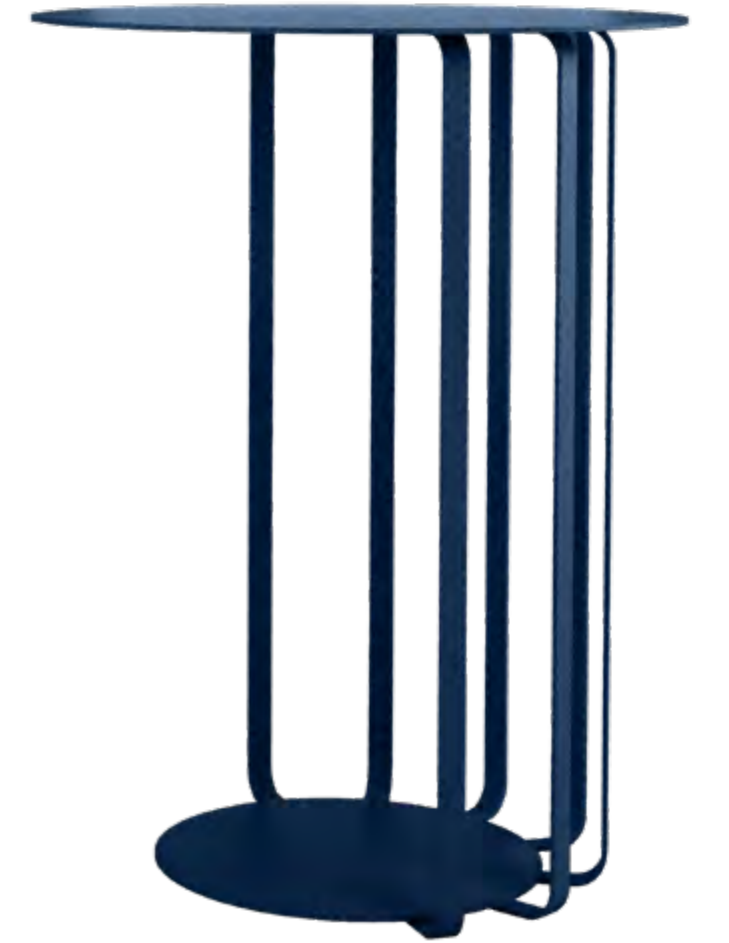



Mood Coffee table 66, Burgundy finish / Sorella Sideboard, Natural oak finish

Mood 66

PALETTE OF FINISHES

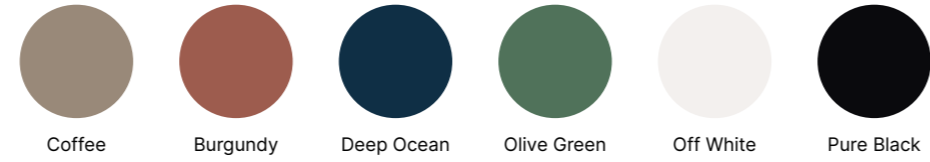

KEY FEATURES

Dimensions :
height: 66 cm
top size: 50 cm

Materials:
Top: Steel
legs: Steel

Production
2021, Created in Poland

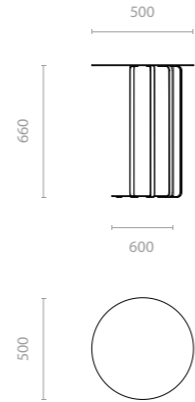

DESIGNERS

Fondu × Ewelina Madalińska

Industrial Design, graduate of the Academy of Fine Arts in Łódź and Product Design at German university at Hochschule Niederrhein. She runs design studio "Wyborne"



Gabbia Cabinet131, Walnut oak finish / Primavera Planter 45, Burgundy finish / Mood Coffee table 66, Coffee finish / Madera TV Stand 140, Petra finish



Primavera Planter45, Coffee finish / fragment Nastro Console, Off White finish

PLANTERS

Primavera





Primavera Planter 45, Off White finish / Primavera Planter 55, Coffee Tone finish

Primavera

RANGE OF FINISHES

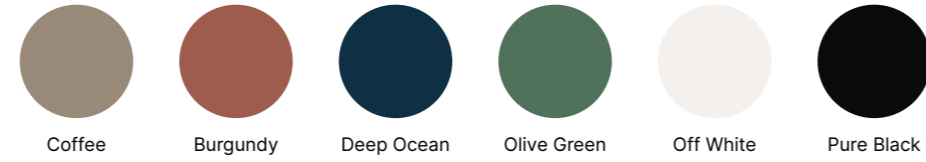

KEY FEATURES

Dimensions :

The bigger size:
height: 55 cm
diameter: 32 cm
depth: 20 cm

The smaller size:
height: 45 cm
diameter: 32 cm
depth: 20 cm

Materials:

Top: Steel
legs: Steel

Production

2021, Crafted in Poland

PROJEKT

Fondu × Ewelina Madalińska

Industrial Design, graduate of the Academy of Fine Arts in Łódź and Product Design at German university at Hochschule Niederrhein. She runs design studio "Wyborne"

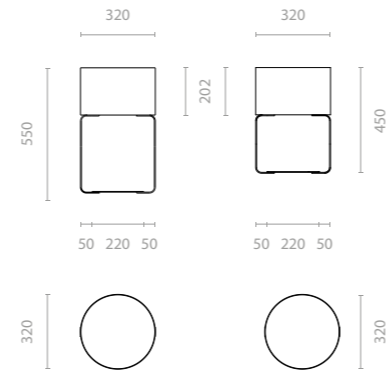

Primavera 45 Planter, Coffee tone finish / Primavera 55 Planter, Off White finish / Primavera 55 Planter, Pure Black finish / fragment Nastro Console, Pure Black finish



Nastro Console, Off WhiteFinish / Mood 66 Coffee table, Olive Green finish

CONSOLE
Nastro





Nastro Console, Off White finish

Nastro

RANGE OF FINISHES

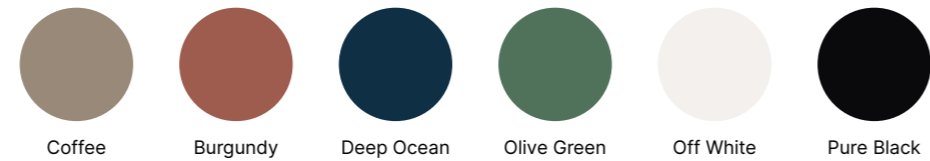

Coffee

Burgundy

Deep Ocean

Olive Green

Off White

Pure Black

KEY FEATURES

Dimensions :

height: 90 cm
 diameter: 120 cm
 depth: 40 cm

Materials:

Top: Steel
 legs: Steel

Production:

2021, Crafted in Poland

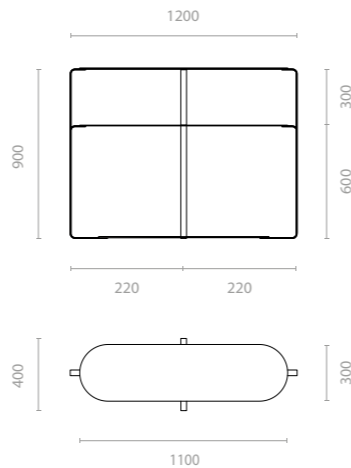

DESIGNERS

Fondu x Ewelina Madalińska

Interior Designer Industrial Design, graduate of the Academy of Fine Arts in Łódź and Product Design at German university at Hochschule Niederrhein. She runs design studio "Wyborne".



Nastro Console, Pure Black finish



Armonia 160 Bookshelf, Walnut Oak finish

Metropolii Collection

Fondu × Pawlak & Stawarski





Armonia Bookshelf 120, Natural Oak finish

The Metropoli collection is more than just furniture - it is functional art, perfectly tailored to the seemingly contradictory aspirations of modern individuals.

In today's world, we eagerly embrace the advancements of the latest technology, while our daily environment often transforms into concrete jungles, striking in their rawness yet alluring with their limitless perspectives. At the same time, we yearn for simplicity and harmony. Fortunately, we no longer have to choose between drawing inspiration from modernity or returning to the familiar and secure.

The Metropoli collection invites nature into your home, transforming your space into a private oasis - a serene retreat that allows you to momentarily escape the daily rush.

The collection includes

- Impero Sideboard
- Dinamica Coffee table
- Duo Coffee table
- Armonia bookshelf



Impero Sideboard, Natural Oak finish / Impero Sideboard Walnut oak finish / Dinamica, Vulcanic + Deep Ocean + Natural oak finish / Armonia Bookshelf 120, Natural Oak finish / Dinamica Coffee table



Impero Sideboard, Natural Oak finish

SIDEBOARD

Impero



Impero

PALETTE OF FINISHES



Natural
Oak



Walnut
Oak

KEY FEATURES

Dimensions :

height: 93,6 cm
width: 146 cm
depth: 45 cm

Materials:

Body: solid oak wood
Legs: solid oak wood

Production:

2021, Handcrafted in Poland

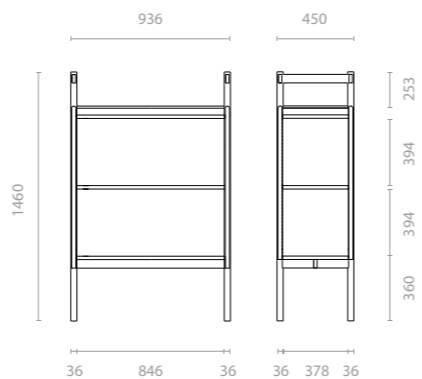

DESIGNERS

Fondu × Pawlak & Stawarski



Impero Sideboard, Walnut oak finish



Impero Sideboard, Natural oak finish



Dinamica Coffee table, Vulcanic + Walnut oak finish

COFFEE TABLE

Dinamica





Dinamica Coffee table, Vulcanic finish + Walnut oak+ Deep Ocean finish



Dinamica Coffee table, Vulcanic + Walnut oak finish

Dinamica

PALETTE OF FINISHES

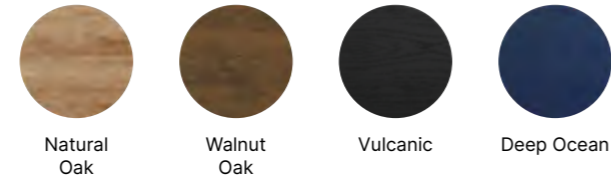

KEY FEATURES

Dimensions :
height: 66 cm
top: 50 cm

Materials:
Top: solid oak wood
Legs: steel

Production
2021, Handcrafted in Poland

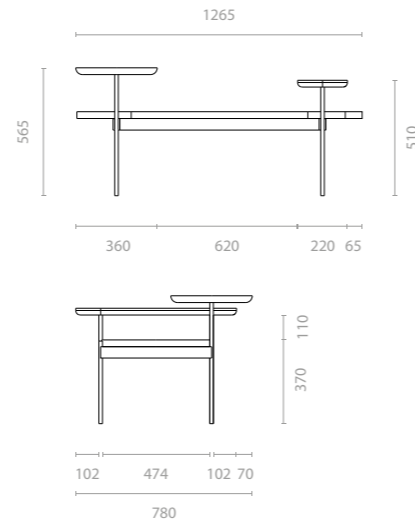

DESIGNERS

Fondu x Pawlak & Stawarski



Dinamica Coffee table, Vulcanic + Walnut oak / Raggi Prime Panels, natural oak finish



Duo Coffee table, Natural oak finish / Madera TV stand 210, Vulcanic finish / Primavera Planter 55, Coffee finish

COFFEE TABLE

Duo





Duo Coffee table, walnut oak finish

Duo

PALETTE OF FINISHES

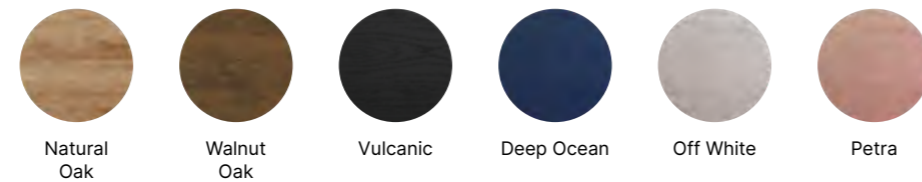

KEY FEATURES

Dimensions :

height: 88 cm
width: 38,7 cm
depth: 74,2 cm

Materials:

Moon Top: Blanco Ibiza Marble, 2 cm thickness
Round Top: solid oak wood
Legs: steel

Production

2022, Handcrafted in Poland

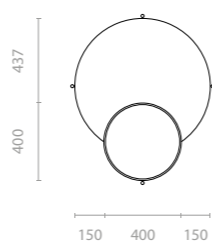
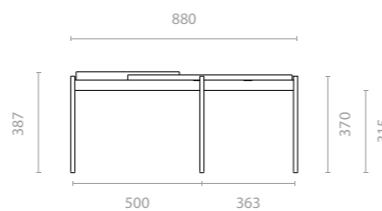

DESIGNERS

Fondu x Pawlak & Stawarski





Armonia Bookshelf 160, walnut oak finish



Armonia Bookshelf 120, natural oak finish

BOOKSHELF

Armonia





Armonia Bookshelf 20, Natural Oak finish

Armonia

PALETTE OF FINISHES



Natural Oak



Walnut Oak

KEY FEATURES

Dimensions :

Armonia 120
height: 194,5 cm
width: 127,2 cm
depth: 39,2 cm

Armonia 160
height: 194,5 cm
width: 167,2 cm
depth: 39,2 cm

Materials

Shelves: solid oak wood
Side Legs: solid oak wood
Central Legs: steel

Production

2021, Handcrafted in Poland

DESIGNERS

Fondu x Pawlak & Stawarski

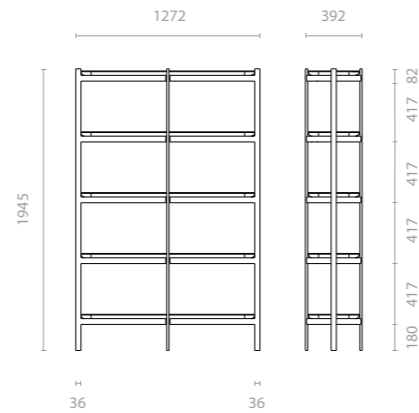

Armonia Bookshelf 160, Walnut Oak finish



Madera 140 TV stand, Vulcanic finish / Veroni side table, Vulcanic finish / Primavera Planter 45, Off White finish / Raggi prime panels, Natural Oak finish

Pannelli Collection

Fondu × Ewelina Madalińska

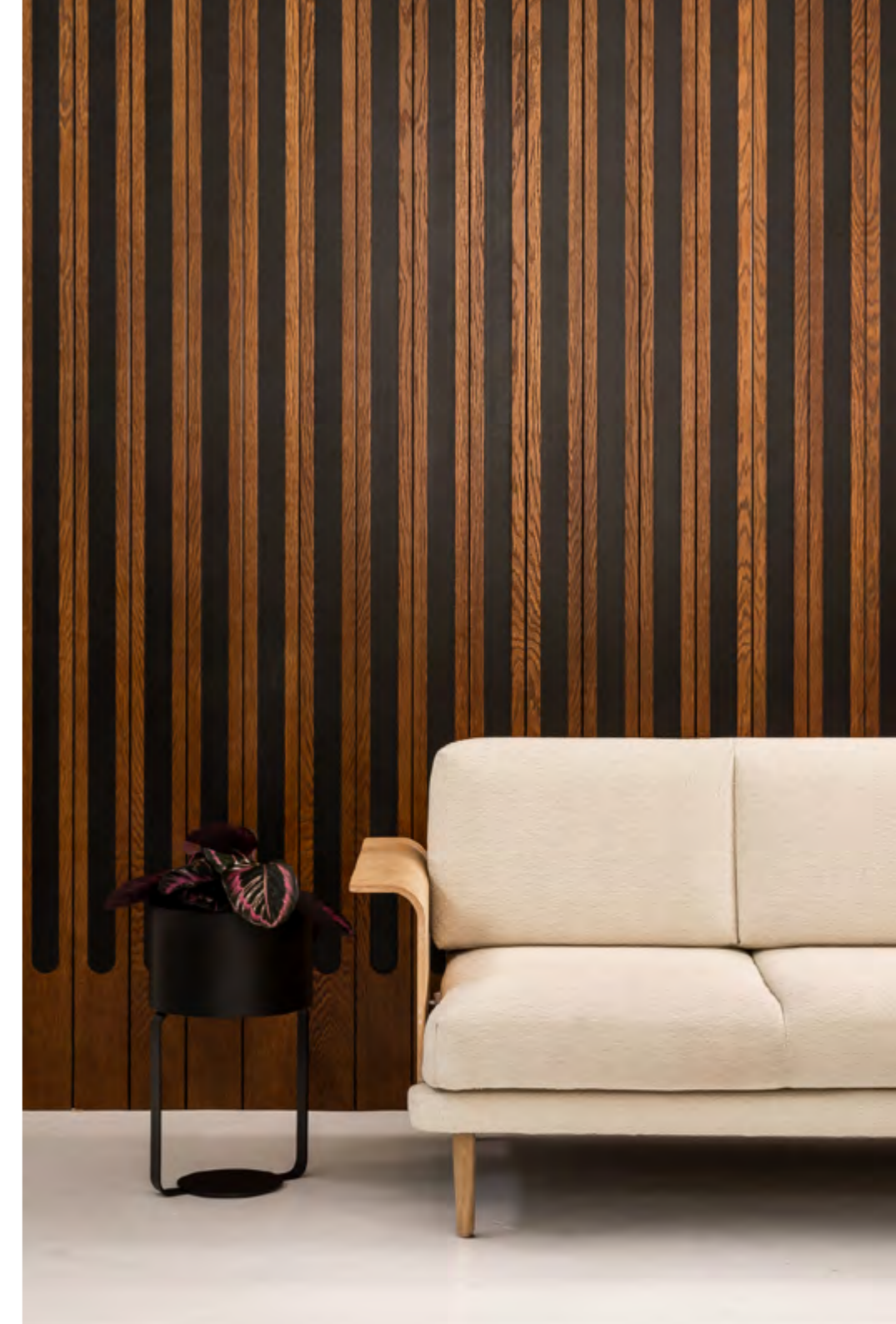



Raggi Wall Panels, natural oak finish / Madera TV stand 190, Vulcanic finish

The Pannelli Collection was created in response to the need to integrate interior architecture with furniture design.

Our design proposals not only complement wall spaces but also integrate seamlessly with furniture compositions. These panels are perfect for enhancing TV walls, bedrooms, or sophisticated hallways. Each pattern is crafted using the finest oak veneer with a flader oak finish, ensuring authenticity and a natural touch for any interior.

The collection includes:

- Arco Wall Panels
- Raggi Wall Panels



Gabbia Cabinet177, walnut oak finish / Raggi Wall panels, walnut oak finish / Dinamica Coffee table, Vulcanic + Deep Ocean + Walnut Oak finish / Veroni Side table Deep, Ocean finish



Gabbia Console 177, Burgundy finish / Dinamica Coffee Table, Natural Oak + Vulcanic finish / Veroni Side Table, Burgundy finish

WALL PANELS

Arco

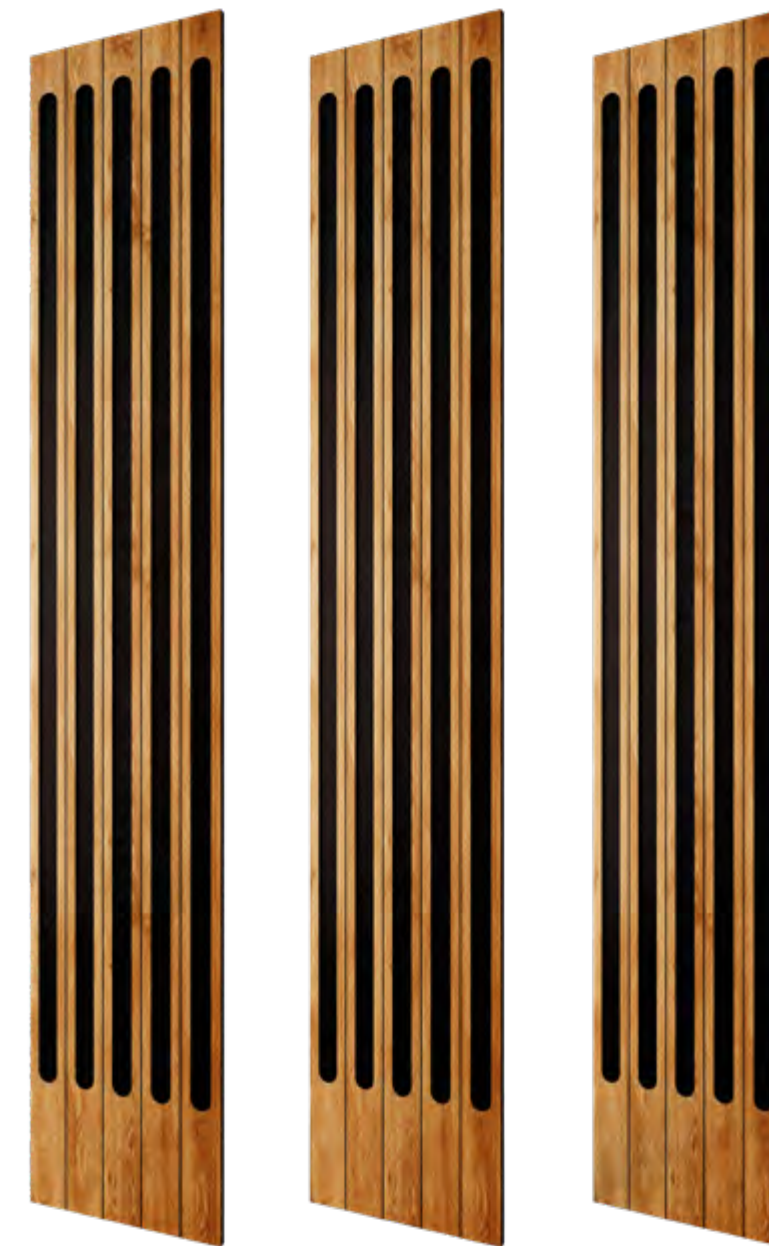



Gabbia Console 177, Vulcanic finish / Arco Wall Panels, walnut oak finish

Arco

PALETTE OF FINISHES

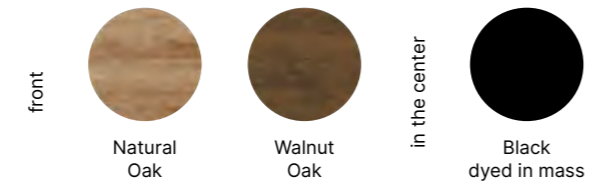

SPECIFICATIONS

Dimensions :

height: 280 cm
width: 50 cm
depth: 2 cm

Materials:

Front: oak flader veneer with lacquered finish and visible wood texture
Base: MDF, dyed in mass
Grooves: MDF, dyed in mass

Production

2022, Handcrafted in Poland

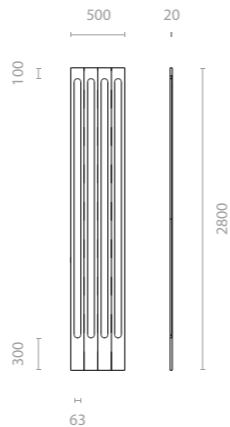

DESIGNER

Fondu x Ewelina Madalińska

Interior Designer Industrial Design, graduate of the Academy of Fine Arts in Łódź and Product Design at German university at Hochschule Niederrhein. She runs design studio "Wyborne"





Gabbia Cabinet 177, Walnut Oak finish / Raggi Wall Panels, Walnut Oak finish / Dinamica Coffee table, Vulcanic + Deep Ocean + Walnut Oak finish / Veroni Side table, Off Blue finish

WALL PANELS

Raggi

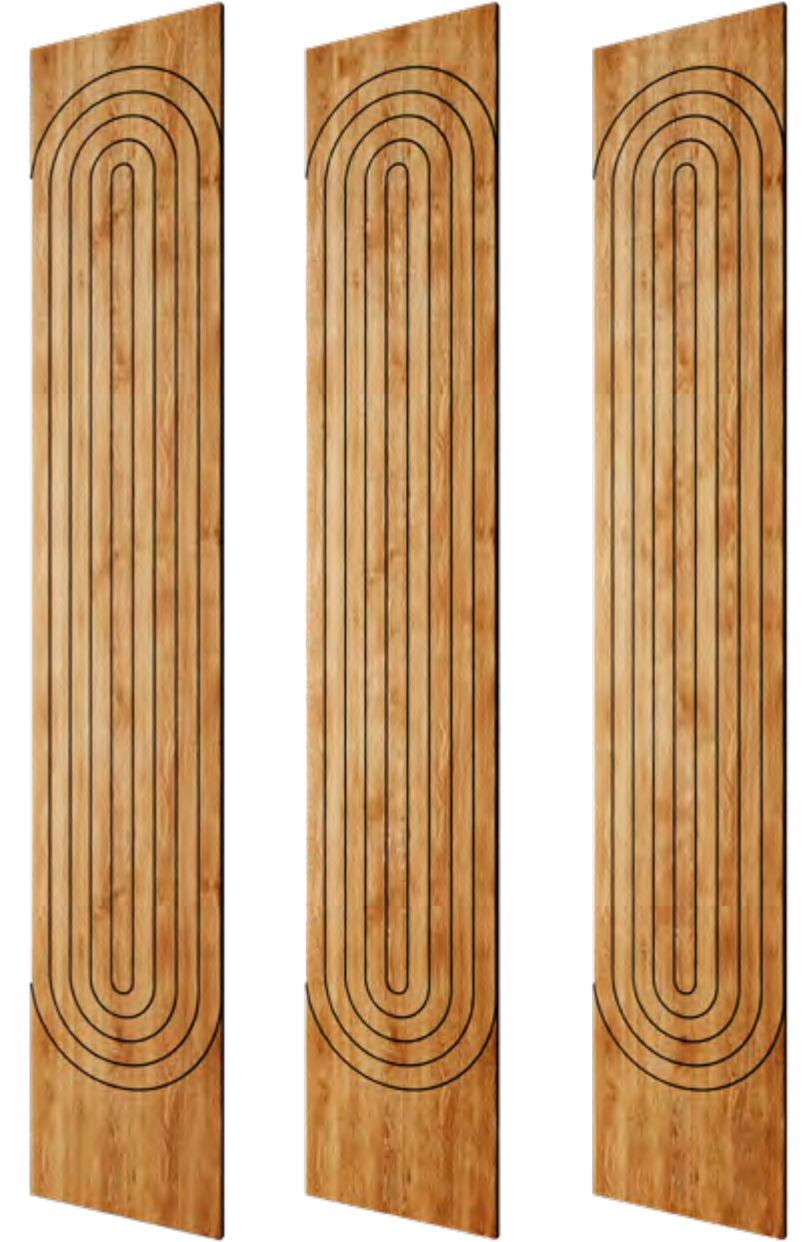



Madera TV stand 140, Vulcanic finish/ Veroni Side table, Vulcanic finish / Primavera Planter 45, Off Whitefinish / Raggi Wall Panels, natural oak finish

Raggi

PALETTE OF FINISHES

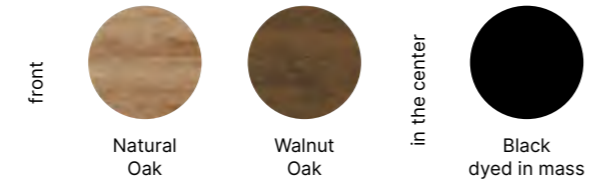

SPECIFICATION

Dimensions :

height: 280 cm
width: 50 cm
depth: 2 cm

Materials:

Front: Oak flader veneer with a lacquered finish and visible wood texture
Base: MDF, dyed in mass
Grooves: MDF, dyed in mass

Production

2022, Handcrafted in Poland

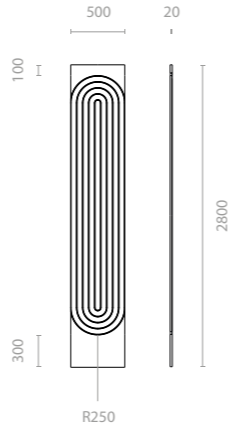

PROJEKT

Fondu × Ewelina Madalińska

Interior Designer Industrial Design, graduate of the Academy of Fine Arts in Łódź and Product Design at German university at Hochschule Niederrhein. She runs design studio "Wyborne"



Raggi Wall Panels, natural oak finish / Dinamica Coffee table, Vulcanic + walnut oak finish

Let's start a collaboration.
Feel free to contact us.

Konrad Wasilewski
e: kondrad@fнду.pl
t: + 48 603 133 033

